

Performance Analysis of Adaptive Neuro Fuzzy System to Control Power Flow in Islanded Microgrid

Sandesh Paudel^{1*}, Bipana K.C.¹, Aadarsh Sharma¹, Abhinaya Chhetri¹, Menaka Karki¹

¹ Department of Electrical Engineering, IOE, Pashchimanchal Campus, Tribhuvan University, Nepal
(Manuscript Received 16/08/2022; Review: 30/09/2022; Revised 03/10/2022; Accepted 05/10/2022)

Abstract

A Micro Grid (MG) is a small-scale distribution network that connects a big network (host grid) as a single controllable entity and has a series of distributed generations meant to offer electrical power to a local area. There are two types of microgrids: grid-connected and islanded. The MG will switch to islanding mode if a serious fault occurs in the primary distribution network. Because of the absence of inertia and poor performance of PI-based inverter control, power and frequency levels will fluctuate more in the islanded mode than in the grid linked mode. It is vital to utilize an efficient control strategy to alter the system voltage and frequency when the microgrid is islanded. In this case, droop control is one of the easiest ways for managing voltage and frequency. It can be used to set the voltage and frequency of the system to safe levels. This project demonstrates the use of an adaptive neural-fuzzy system for power flow control in response to variations in consumption within an isolated microgrid, in order to improve the system's performance. According to the actual operation circumstances, PQ control can achieve targeted control of real and reactive power of DGs. While the load power varies, V/f control can achieve power sharing between multiple DGs and offer frequency support when in islanded mode. The microgrid system may move between both the islanding and grid-connected modes, without affecting connected essential loads thanks to its approach. By switching between interconnected and islanded modes in MATLAB/SIMULINK, the two control techniques were verified in simulation.

Keywords: ANFIS (Adaptive Neuro-fuzzy Inference Systems), DG (Distributed Generation), PWM (Pulse Width Modulation), PQ Control, SVPWM (Space Vector Pulse Width Modulation), V/f Control

1. Introduction

A Micro Grid (MG) is a small-scale distribution network containing a set of DG designed to supply electrical power to a local area, connected to a large network (host grid) as a single controllable entity [1]. A MG can operate in two modes. Grid-connected mode refers to when the MG's energy demand is met by the main grid, whereas islanded mode refers to when demand is met by the MG's own local generation.

The voltage and frequency in grid-connected mode are normally kept within the grid value limits. Here, active and reactive power among the DGs is distributed as well as power exchange is managed between the MG and the utility grid. On the other hand, since the voltage and frequency are altered, they may exceed their permitted limitations in islanded mode and also have no support from the grid system. PQ (current control) approach can effectively manage current and navigates grid disturbances but is difficult during islanded mode as their focus is upon the current. Vf (voltage control) approach provides direct voltage support, and

with just slight modifications, they can operate in both modes [2].

The MG will switch to islanding mode if a serious fault occurs in the primary distribution network. Because of the lack of inertia and poor performance of PI-based inverter control in the islanded mode of the MG network, fluctuation in power and frequency levels can be predicted to be higher during transient situations than in the grid-connected mode [3].

Various research has been done including on the utilization of different modern optimization methods embedded in the conventional PID controller for load frequency control [4]. The simulation circuits in the article [5] were created specifically for the PSIM droop control technique. The output waveform is also examined. The islanded MG model was implemented in paper [6] with a reverse droop based on a virtual impedance control strategy for the VSI and power management control strategy to ensure better power sharing among DG sources with frequency level and power balance regulation and coordinated DG source control operation.

ANFIS is an adaptive network that allows the implementation of neural network topology, together with

*Corresponding author. Tel.: +977- 9846-880-052,
E-mail address: sandeshpd134@gmail.com

fuzzy logic. ANFIS is a class of adaptive multilayer feeding forward networks, which is functionally equivalent to a fuzzy inference system [6]. The training of the ANFIS is taken from power flow results using 'power world simulator' software which showed a clear improvement in terms of rapidity and feasibility. In this paper, a comparative study is performed between ANFIS' performance in controlling power flow in the microgrid with that of the PI controller.

2. Control Strategy and Methodology

2.1 Droop Control

Droop control is a decentralized control approach for distributed generation grid inverters, which regulates active power production based on frequency deviation and adjusts reactive power output based on voltage deviation [7]. The droop control method is utilized to commence the P-f and Q-v characteristics of the synchronous machine. The droop controller is an easier way to control islanded MG.

P&Q Control takes reference power and reference voltage as input and generates the reference currents I_{dref} and I_{qref} which are given as input to the current control loop to obtain reference voltage as output. The reference voltage is given as input to the SVPWM to generate the pulse width modulation signals for switching the inverter.

In V/f control, the voltage control loop stabilizes the system, while the current control loop increases the system's dynamic response. The reference voltage is compared with components of the grid in the voltage control loop which gives the reference current. This current is fed to the current control loop and compared with inverter current and reference voltage for PWM generation is obtained.

2.2 Adaptive Neuro-Fuzzy Interference System (ANFIS)

Adaptive Neuro-fuzzy systems are a new approach to modeling and controlling complex systems that allow for data-driven parameter adaptation. An adaptive neural fuzzy system is a learning machine that uses neural network approximation techniques to determine the parameters of a fuzzy system (i.e., fuzzy sets, and fuzzy rules). For the project, Adaptive Neuro Fuzzy Inference System was implemented in MATLAB.

The adaptive neuro-fuzzy system was trained with

the data set, retrieved by comparing the dq components of the reference voltage (grid voltage) with the om component of inverter voltage in the case of grid-connected mode. While in the islanded mode the reference voltage was generated by the grid forming inverter which was assigned DG2. In the same way, the data for the current too was extracted for both modes: grid-connected mode and islanded mode. With the help of the ANFISEDIT tool of MATLAB, the data obtained was used to train the ANFIS system with triangular member functions and for about 50 epochs to get the minimum error tolerance set at 0. Hybrid optimization was used while training the Fuzzy Interference System

2.3 Methodology

Two micro sources and an AC grid are used in the proposed scheme's simulation. The switching signals of the Universal-bridge inverter are accomplished using Insulated Gate Bipolar Transistors (IGBTs) and diodes, with a 2-level Space Vector Pulse Width Modulation (SVPWM) approach.

Two micro sources, DG1 and DG2, must be synced with the grid. Both DG1 and DG2 are providing power to their key loads. In grid-connected mode, DG1 always has PQ control, whereas, in grid disconnected mode, DG2 has PQ control and V/f control. The master DG is DG2 and DG1 is the affiliated DG in grid disconnected mode. To give voltage and frequency reference, DG2's control switches to V/f mode.

The SVPWM is defined as an alternative way of determining switching pulse width and position. The main advantage of SVPWM is that it allows for some flexibility in space vector placement throughout its switching cycle. This increases the method's harmonic performance [8]. Using the space-vector pulse width modulation (SVPWM) approach, this block creates PWM reference signals for three-phase 2-level inverters.

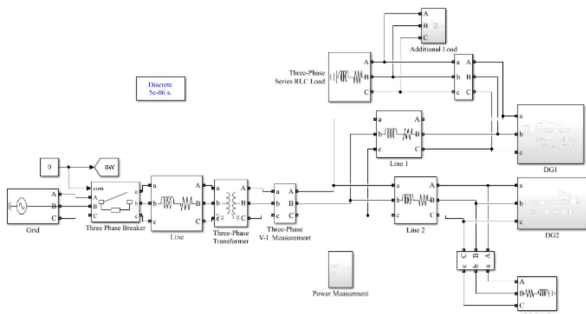

Figure 1 Simulation Model of the System

Droop control is a control approach for distributed generation grid inverters to regulate active power production based on frequency deviation and adjusts reactive power output based on voltage deviation. The droop control block includes “Q versus V Droop” and “P versus f Droop”

$$f = f_n - (P_n - P)/m \quad (i)$$

$$v = V_o - Q/n \quad (ii)$$

where f_n denotes the reference frequency, P_n is the reference power, P denotes the active power, m and n are droop coefficients, V_o is the reference voltage and Q denotes the reactive power.

For DG1, we take a DC source and it is converted to AC by a 2-level converter which is triggered by the PWM signals from the PQ control block. This AC output is filtered by an LCL filter to remove the harmonics. For DG2, we take a DC source and it is converted to AC by a 2-level converter which is triggered by the PWM signals from either the PQ control block or V/f control block. This AC output is filtered by an LCL filter to remove harmonics.

Table 1. Different Action Sets

0-0.5 sec	DG1: PQ control mode DG2: PQ control mode
0.5sec – 1sec	DG1: PQ control mode DG2: V/f control mode
1sec – 1.5 sec	DG1: PQ control mode with additional load DG2: V/f control mode
1.5sec – 2 sec	DG1: PQ control mode with additional load DG2: PQ control mode

3. Results and Discussion

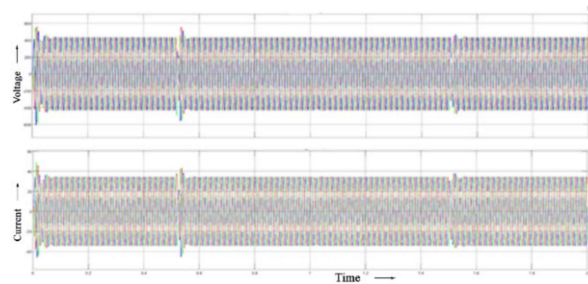

Following are the waveforms of output power with the use of PID in Figure 2, and with the use of the ANFIS in Figure 3. In the figures, the first 0.5 sec is in grid-connected mode, 0.5-1 sec in grid disconnected mode, 1-1.5 sec in grid-disconnected with additional load and 1.5-2 sec in grid-connected with the additional load.

Figure 4 Active Power Flow with PID (Zoomed View)

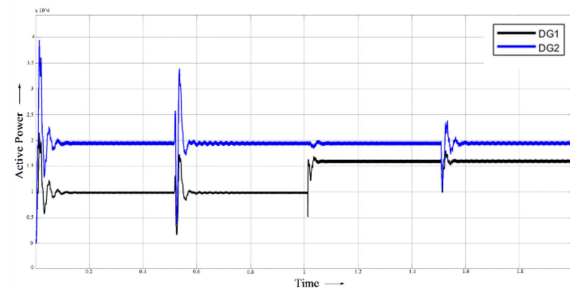

Figure 2 Active Power Flow with PID

According to the action sets, the active power flow from two DGs is obtained in figure 2. The transients in the graph are due to the switching actions because of the intentional islanding mode. As seen the power flow in both the DGs become constant after some fraction of a second and the power flow to the load is as desired. The connection of additional load at 1 sec is also incorporated in both islanding mode as well as grid-connected mode.

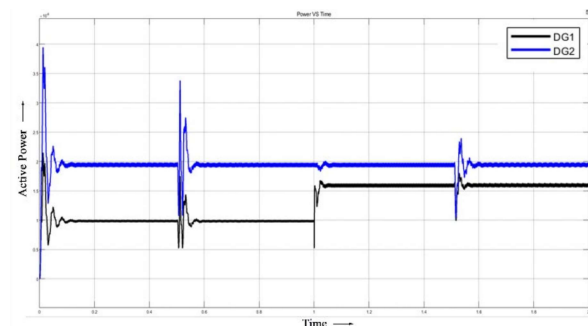

Figure 3 Active Power Flow with ANFIS

Figure 3 shows the active power flow with the ANFIS

controller with the same action set as mentioned in the table of action sets.

Hence, from multiple simulation runs, we obtain the result that the response time of ANFIS is slightly better than that of PID by 4% to 10% while changing from the grid-connected to the disconnected mode, which can be seen from zoomed view in figure 4 and figure 5.

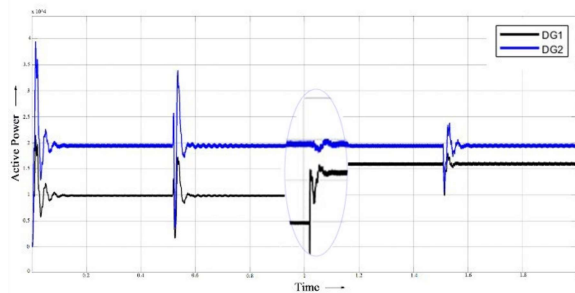

Figure 4

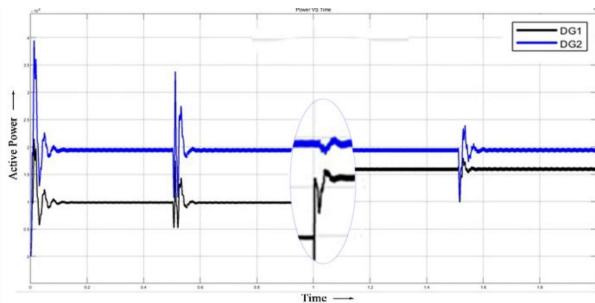

Figure 5 Active Power Flow with ANFIS (Zoomed View)

As the transitions have been made in between the operation various spikes can be seen in the waveforms. The waveforms of output voltages and currents of both DG1 and DG2 are synchronized and normal as expected in both grid-connected and disconnected modes as seen in figure 6 and figure 7. The voltage of DG1 is constant as it is PQ controlled hence the power is also constant in both grids connected as well as islanded mode.

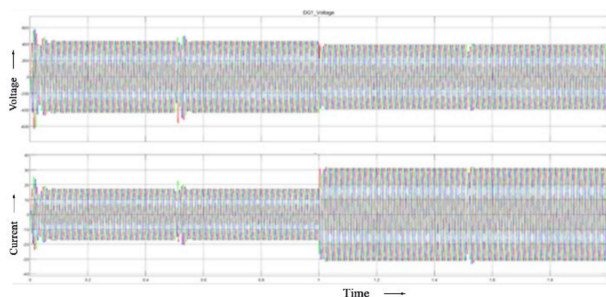

Figure 6 DG1 Voltage and Current

Figure 6 shows the DG1 voltage and current. The grid-connected mode and islanded mode without additional

load are the same. When the additional local load has been connected the waveform of voltage decreases slightly by about 5% which is within the permissible range. To meet the power in the current increases as seen in figure 6.

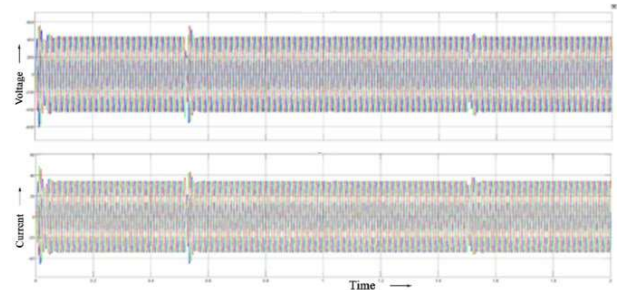

Figure 7 DG2 Voltage and Current

Figure 7 shows the current and voltage of DG2 which shows the voltage is kept constant in either grid connected mode or islanded mode. The output power of DG2 is constant as no any common load was connected between the two DGs. DG2 is in V/f mode during the islanded mode.

As seen in the voltage and current graph in figure 6 and figure 7 of two DGs the synchronization with the grid is rapid. The frequency of the system remains within the permissible limits when observed.

Both DG1 and DG2 operated in grid-connected as well as islanded mode. DG2 act as the grid forming DG when operated in the islanded mode while the DG1 always operated on PQ control mode. The voltage level of both DGs is within the permissible range and fluctuates about 5% of the grid voltage. The frequency of both DGs is synchronized to grid frequency and no fluctuation is observed during the process followed.

4. Conclusion

PQ control and V/f control are two microgrid control techniques presented in this paper. When both the DGs are connected to grid they follow grid voltage and operate in PQ control mode. When the grid fails or disconnects, DG2 produces the references as a result of V/f control mode for DG1 to follow in islanded mode. The power flow in such system with the ANFIS controller produced better results than the PID controller in both mode of operation. MATLAB/SIMULINK simulations demonstrated the effectiveness and robustness of the ANFIS controller.

References

- [1] Hossain M. A., Pota H. R., Hossain M. J., and Blaabjerg F. Evolution of microgrids with converter-interfaced generations: Challenges and opportunities, *Int. J. Electr. Power Energy Syst.*, 109 (2019) 160–186 . doi: 10.1016/j.ijepes.2019.01.038.
- [2] Khajehoddin S. A., Karimi-Ghartemani M., and Ebrahimi M. Grid-supporting inverters with improved dynamics. *IEEE Transactions on Industrial Electronics*, 66(5), (2019) 3655–3667. doi-2018.2850002.
- [3] Espitia H. E., Machón-González I., López-Garc H., D-Az G., and Garrido A. J. Proposal of an Adaptive Neurofuzzy System to Control Flow Power in Distributed Generation Systems, (2019). doi: 10.1155/2019/1610898
- [4] Abdelaziz A. Y. and Ali E. S. Cuckoo Search algorithm-based load frequency controller design for non-linear interconnected power system, *Int. J. Electr. Power Energy Syst.*, 73 (2-15) 632–643. doi: 10.1016/j.ijepes.2015.05.050.
- [5] Qin L .and Yang W. Micro-Grid Droop Control Strategy and Isolated Island Operation System Stability Analysis, *WSEAS Trans. POWER Syst.*, 10 (2015) 145–156.
- [6] Abdellah D. and Djamel L. Power flow analysis using adaptive neuro-fuzzy inference systems, *Proc. 2015 IEEE Int. Renew. Sustain. Energy Conf. IRSEC 2015*, (2016) 15–19. doi: 10.1109/IRSEC.2015.7455102.
- [7] Yang X., Zong X., Yang F., and Zang H. Y. A research on droop control strategy and simulation for the micro-grid, *2011 Int. Conf. Electr. Control Eng. ICECE 2011 - Proc.*, (2011) 5695–5700. doi: 10.1109/ICECENG.2011.6057281.
- [8] Iqbal A. Space Vector PWM Techniques, (2012).
- [9] Ekanayake U. N. and Navaratne U. S. A Survey on Microgrid Control Techniques in Islanded Mode, *J. E. and C. Engineering.*, (2020).