

## Effect of masonry wall on Strength and Ductility in common RC frame low storey buildings

Anup Poudel\*, Rajan Suwal

Department of Civil Engineering, Pulchowk Campus, Institute of Engineering, Lalitpur, Nepal

### Abstract

The Nepal National Building code (NBC) was promulgated in 2003 and is divided into four different parts in order to cover buildings constructed in Nepal. NBC 105 has undergone a major update in 2020 with its repercussions on existing prevalent buildings. So, in this paper effort has been made to understand municipal drawings submitted to municipalities constructed with current prevalent building construction practice with column size of 300mm x 300mm, 300mm x 230mm and 230mm x 230mm. Moreover, effects of masonry infill are considered with a separate model considering an equivalent strut as per IS 1893:2016. Ten sample buildings were selected after a rigorous sampling process of over 5000 municipal drawings to represent typical buildings. Non-linear static pushover analysis was conducted on those ten buildings and twenty models. There has been an increase in the over-strength factor of the buildings while there was reduction in ductility factor of the buildings. Equations are proposed based on non-linear regression analysis to determine the changes in over-strength and ductility factor of the buildings.

*Keywords: Low Storey Buildings; Nepal National Building Code (NBC); Overstrength factor; Ductility factor*

### 1. Introduction

Nepal Building Code (NBC) was introduced in 2003 and included four levels. NBC 000 states, building code is divided into four levels; International state of art (Part I), Professionally Engineered Structures (Part II), Mandatory Rules of Thumb (Part III) and Guidelines for Remote Rural Building (Part IV) [1]. Part III of NBC provided ready to use guidelines without design of buildings from engineers, which prompted large communities to just copy the contents like column sizes, beam sizes and slab thickness. Still most of the drawings submitted to the municipalities belong to part III of NBC. But lately, there has been revision of Nepal National Building Code in 2020 with publication of NBC 105:2020.2 Mandatory rule of thumb code was incorporated in NBC 205 which was first published in 2003 and was updated in draft form in 2012. This code

\*Correspondence to: Anup Poudel

Emails: 076msste003.anup@pcampus.edu.np (A. Poudel), rajan\_suwal@ioe.edu.np (R.Suwal)

provided nominal size of column as 300mm x 300 mm and beam sizes of 230 mm x 350 mm and slab depth of 125 mm. These buildings are designed as a bare frame models.

After Gorkha Earthquake a survey was conducted where most of the buildings built in Nepal were found to be low storey with most buildings below 5 storey and are built with possibility of extension. These buildings comprise of 35-40% of the existing buildings [2]. In municipalities of Nepal, building drawings submitted to the municipalities are modeled and designed as bare frame models. After analysis of seismic demands of buildings with four different buildings, buildings with modified Nepal building code and well-designed structure were found to provide better performance with low-inter storey drifts [3]

Since introduction of NBC 105:2020, the buildings built with provisions stated in NBC 205 might not actually meet the new demands set in by revised standards. So, an effort has been made to understand the behavior of these buildings. Moreover, since these buildings are built with masonry infills, properties of the buildings with masonry infill need to be studied. After the 2001 Bhuj Earthquake in the Kach region of the province of

Gujrat in India, it was found that the presence of masonry throughout the height of the buildings prevented the collapse of many buildings [4]. There was also a separate study on analysis of real bare frame RC building existent in Nepal. It suggested that with increase in ductility of infill, structure can deform for a longer period without collapse which can be beneficial for alternative strengthening techniques [5].

Modeling of infill walls has been suggested in IS 1893:2016. It provided the essential equations in calculating equivalent width of struts to model masonry infill [6]. These equations require modulus of elasticity. And further value of poisson's ratio is required in modeling of strut in finite element packages. An experimental study was done to find the modulus of rigidity and other properties for masonry walls generally used in Kathmandu Nepal. It provides the Young's modulus of 2703.2 N/mm<sup>2</sup>, shear modulus of 915.1 N/mm<sup>2</sup> and Poisson's ratio of 0.32 [7].

Nonlinear static pushover analysis of RC buildings in various configurations was performed where number of storey, the number of bays, and the bay size. Infill walls were not taken into account. The outcome showed that the parameters did not significantly change with the number of bays, but their dependence on the span varied for buildings of all storey. The over strength factor varied significantly when the building configuration changed, while the ductility factors did not exhibit much variation.[8]

building a solid all-optical base to support the rapid development of digital economy and next generation communications [7].

The paper is organized as follows. Section II defines and introduces the F5G followed by development status and trend of F5G in Section III. Section IV presents the role of F5G in industrial transformation and good quality society development. Key features of F5G are presented in Section V, while Section VI presents the F5G development and construction scenario. Section VII concludes the paper.

Here in this work effort has been made so as to incorporate masonry infill walls in change of over strength and ductility factor.

## 2. Materials and methods

Number of building drawings submitted to the municipalities were collected and formed a repository. Buildings were selected so as to replicate the most of the construction practice existing at municipalities outside Kathmandu valley. The Models mentioned below form a representative sample of most of the buildings constructed at urbanizing municipalities.

The model was modeled in standard finite element package ETABS 19. Beam and column elements were modeled as a line element while slabs were modeled as area elements. Since this drawing was submitted to

the municipality, material properties were selected as mentioned in the drawing. Modelling was done for bare frame model and model with masonry infill. ETABS models are presented in figure 1 for model 2.

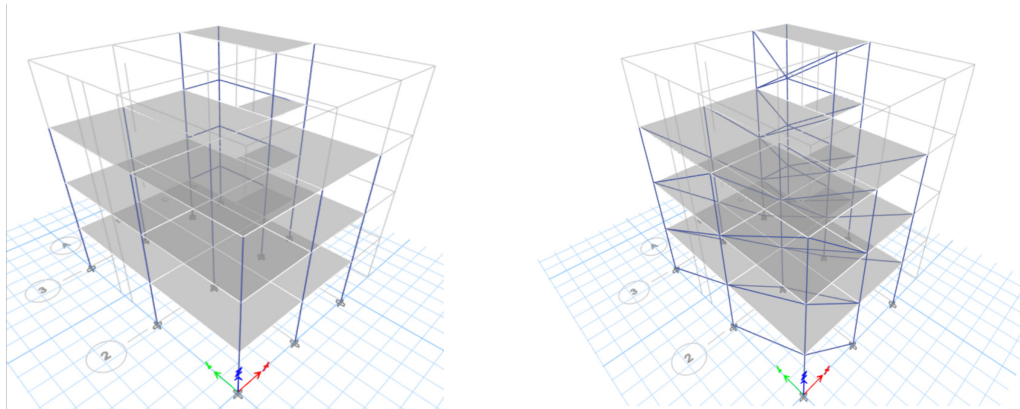

Fig. 1 Bare frame and Infill 3d models for model 2 building

Characteristics of the buildings and material properties are given in Table 1 and 2.

Table 1 Characteristics of building

Concrete grade	M20 (1:1.5:3)
Slab Depth	125 mm
Storey Height	10 feet

Table 2 Material properties of the buildings

Unit weight of concrete	25 KN/m <sup>3</sup>
Unit weight of masonry	20 KN/m <sup>3</sup>
Young's Modulus of masonry	2703.2 N/mm <sup>2</sup>
Poisson's ratio of masonry	0.32

Details of building samples analyzed in the models are as detailed in table 3

Table 3 Details of building sample

Model No.	Storey	Wall thickness mm	Column Size
Model 1	2	115	300 mmx300mm
Model 2	3+Staircase roof	115/230	300 mmx300mm
Model 3	2	230	230 mmx230 mm
Model 4	3+ Staircase roof	230/115	300mmx300mm
Model 5	4+ Staircase roof	230/115	300x300
Model 6	2+ Staircase roof	115	230x230
Model 7	3+ Staircase roof	230/115	230x230
Model 8	3+ Staircase roof	230	230x300
Model 9	3	230/115	300x300
Model 10	4+ Staircase roof	230	230x300

Calculation of seismic load was done on the basis of NBC 105:2020. While equivalent thickness of strut was calculated as per IS 1893:2016

As per Clause 7.9.2.2, (IS 1893:2016 Part 1, 2016)

$$\alpha_h = h \left( \sqrt[4]{\frac{E_m t \sin 2\theta}{4E_f I_c h}} \right)$$

$$w_{ds} = 0.175 \alpha_h^{-0.4} L_{ds}$$

Reduction of opening is done as per equations proposed by (Al-Chaar).[9]

$$R_f = 0.6 \left[ \frac{A_o}{A_p} \right]^2 + 1.6 \left[ \frac{A_o}{A_p} \right] + 1$$

The model was subjected to a nonlinear pushover analysis without masonry infill. ASCE 41-13 NSP (Non Linear Static Procedure) was used to define hinges. Similarly, hinge properties for masonry infill walls were defined as per the constitutive relation proposed by Dolsek and Fajfar. [10]

After definition of load classes and hinges non-linear pushover analysis was conducted. The pushover curve was idealized to obtain the data for the calculation going forward. The idealization is done by an equivalent bilinear curve which is the plot containing the two straight lines. The start of the first line segment starts from the origin and it intersects at  $(V_y, u_y)$  with the second line on the plot. The second line segment continues from the intersected point and ends at the point in the curve having maximum force  $(V_u)$ . The yield base shear is symbolized by  $V_y$  and its corresponding displacement is symbolized by  $u_y$ . The first line segment represents the elastic region. The intersecting point is the point on the plot that represents the nonlinearity of the building. So, the second line segments indicate the elasto-plastic region. FEMA 356:2000 provides a procedure for bilinearization based on the equal energy concept i.e., area under the capacity curve is equal to area under the idealized force displacement curve. The process is based on the iterative method that approximately balances the area below and above the curve.

Overstrength Factor ( $\Omega$ ) is the ratio of Base shear at yield and design base shear.

$$\Omega = \frac{V_y}{V_d}$$

Ductility Factor ( $R_\mu$ ) is calculated as per Miranda 1993. [11]

$$R_\mu = \frac{\mu - 1}{\Phi} + 1 \geq 1$$

Where, Displacement ductility factor ( $\mu$ )

$$\mu = \frac{d_u}{d_y}$$

For alluvium Soil ( $\Phi$ )

$$\Phi = 1 + \frac{1}{12T - \mu T} - \frac{2}{5T} \exp \left[ -2 \left( \ln T - \frac{1}{5} \right)^2 \right]$$

Where,

T is time period of the building

$\mu$  is the Displacement ductility factor appendix.

### 3. Results and discussions

Pushover curves were generated from all the models with consideration as bare frame model and model with masonry strut. Pushover curves generated are discussed in figures 1 to 10.

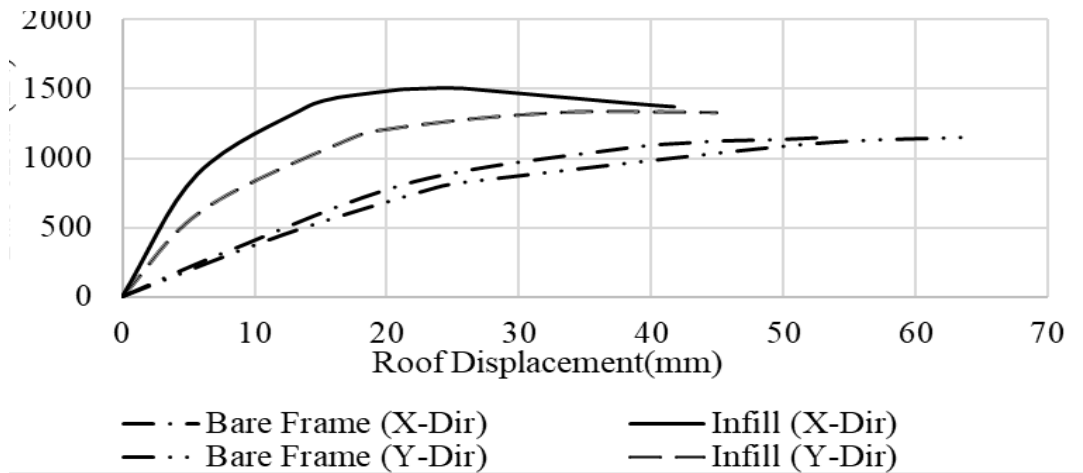

Figure 2 Pushover curve for Model 1

Figure 2 presents the pushover curve of model 1. There was a rise in the pushover curve with infill action. Rise is higher in X direction and reaches to 1500 kN because of lower size of openings and more infill wall along that direction.

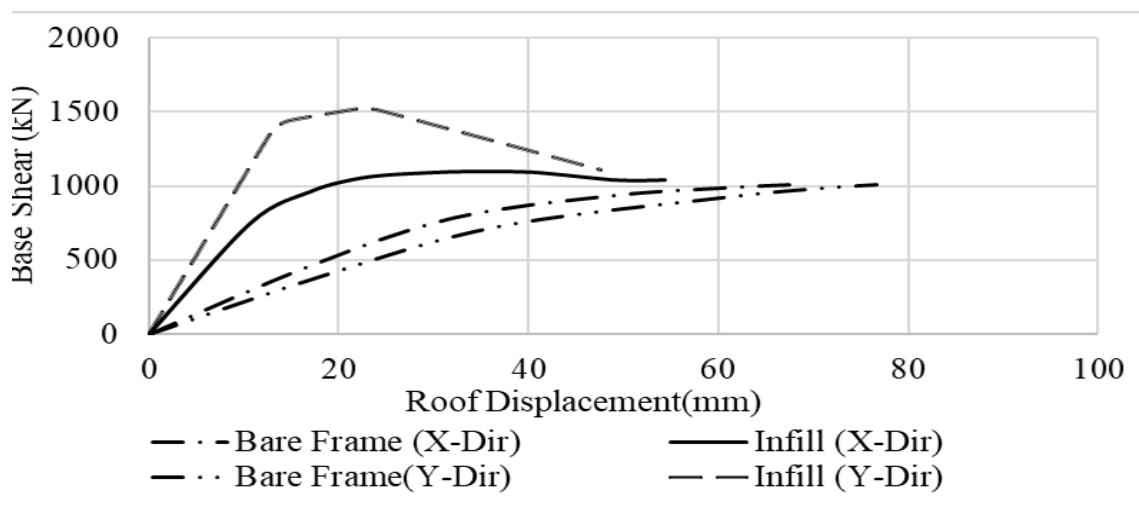

Figure 3 Pushover curve for Model 2

Figure 3 provides pushover curve for Model 2. Ultimate base shear for building is around 1000 kN. There is rise in pushover in Y direction due to higher infill walls of size 230 mm. It has reached to around 1500 kN.

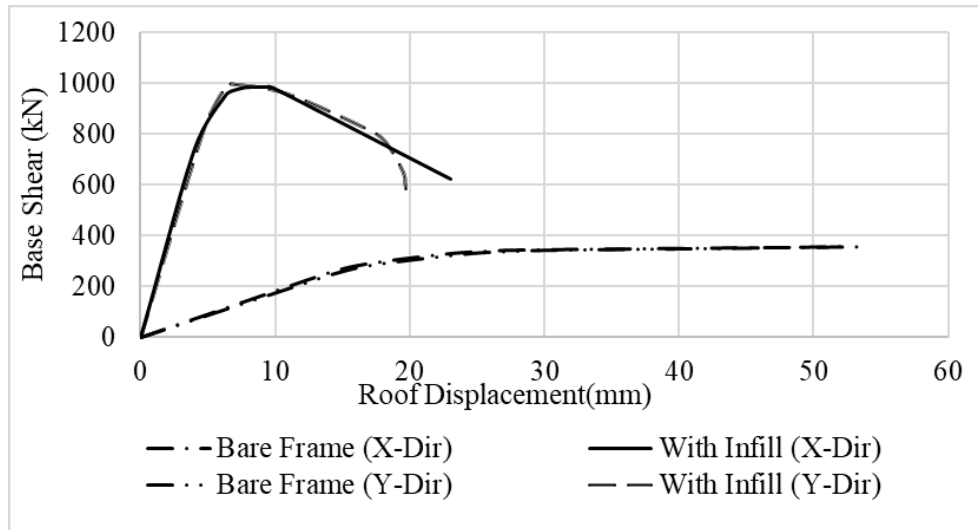

Figure 4 Pushover curve for Model

Figure 4 provides a pushover curve for model 3 with and without infill. Ultimate displacement has been raised from around 400 kN to 1000 kN for both directions as 230 mm walls are provided in both directions. Rise is higher as compared to 115 mm wall.

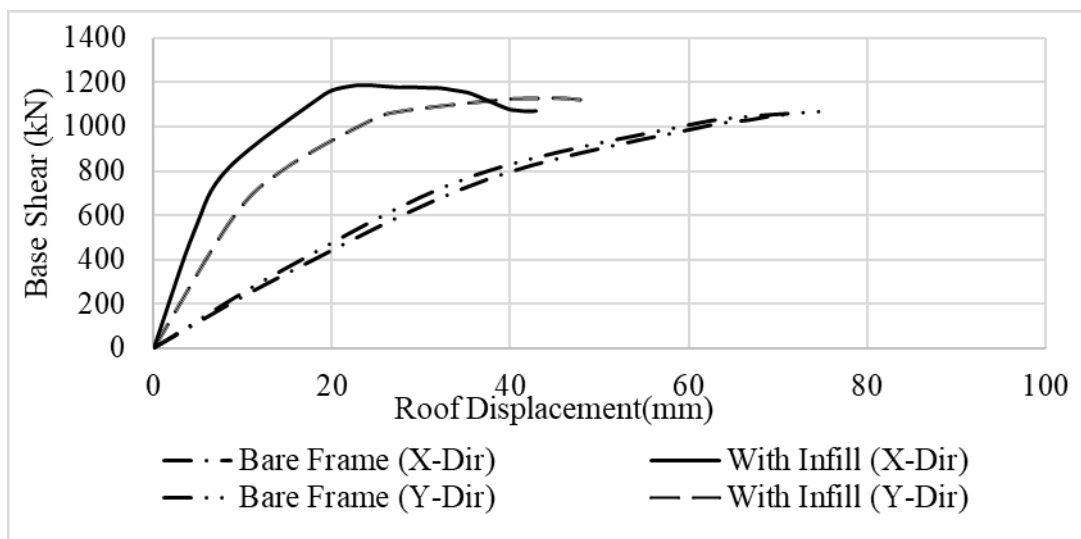

Figure 5 Pushover curve for Model 4

Figure 5 provides a pushover curve for Model 4. Higher initial rise is observed due to infill. Rise is less due to large openings in small bays of buildings and infill not positioned in between the frames.

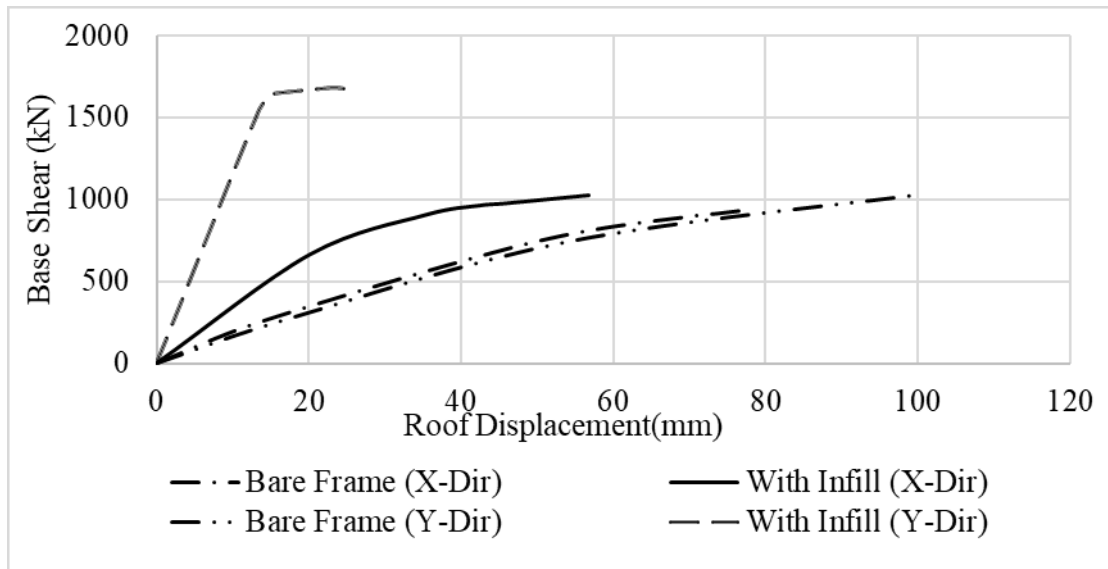

Figure 6 Pushover curve for Model 5

Figure 6 provides a pushover curve with and without infill in model 5. Higher rise is observed in Y direction due to plan irregularity in Y direction and presence of large infill walls in that direction. But the deformation of the building is less and thus reduced ductility is observed due to masonry infill.

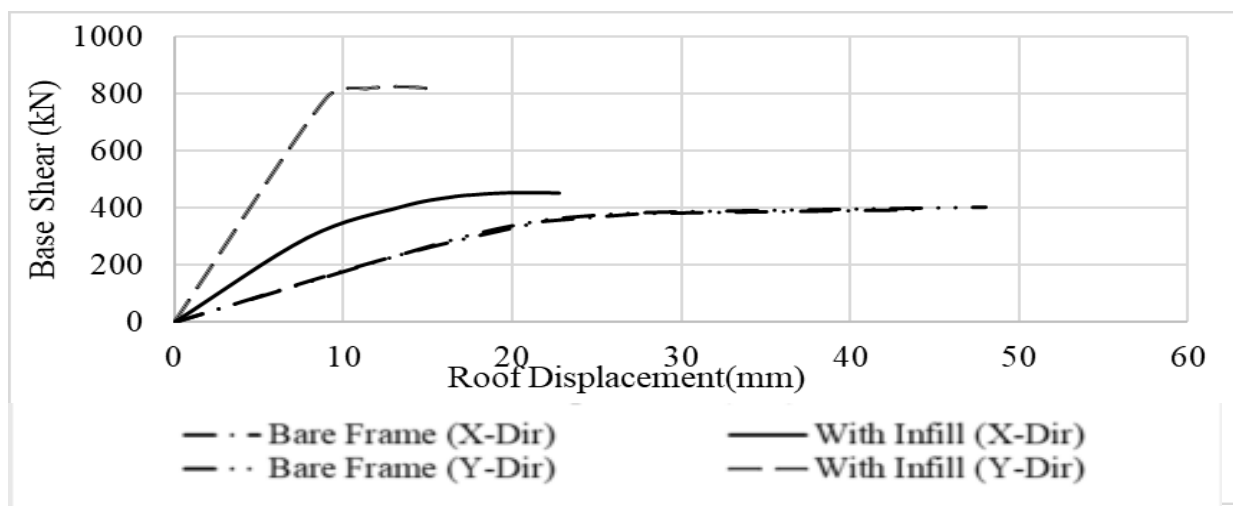

Figure 7 Pushover curve for Model 6

Figure 7 provides a pushover curve for model 6. Its result is comparable with model 6. Higher rise is observed in y direction due to the large number of infill walls in that direction. Rise is less as compared to wall size of 230 mm. In X direction low rise is observed due to presence of openings in walls and wall size of 115 mm.

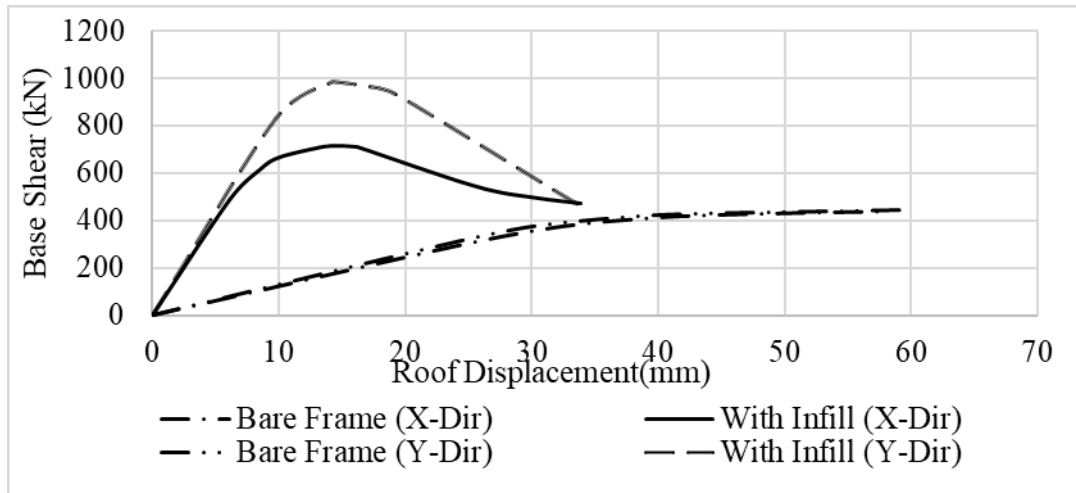

Figure 8 Pushover curve for Model 7

Figure 8 provides a pushover curve for model 7. In bare frame pushover curve is comparable since the building is regular and almost square shaped. But due to 230 mm walls along X direction on only one side, rise of pushover can be clearly observed in Y direction.

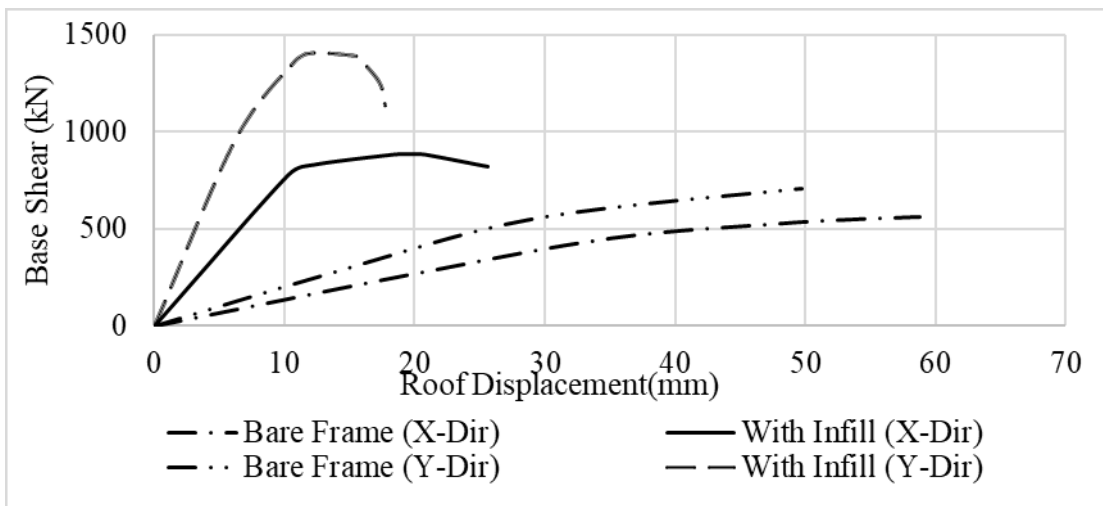

Figure 9 Pushover curve for Model 8

Figure 9 provides a pushover curve for model 8. All the wall sizes are 230 mm. But a large number of infill walls are without openings along Y direction. Similarly columns along X direction are not in a straight line thus it's ultimate strength is lower.



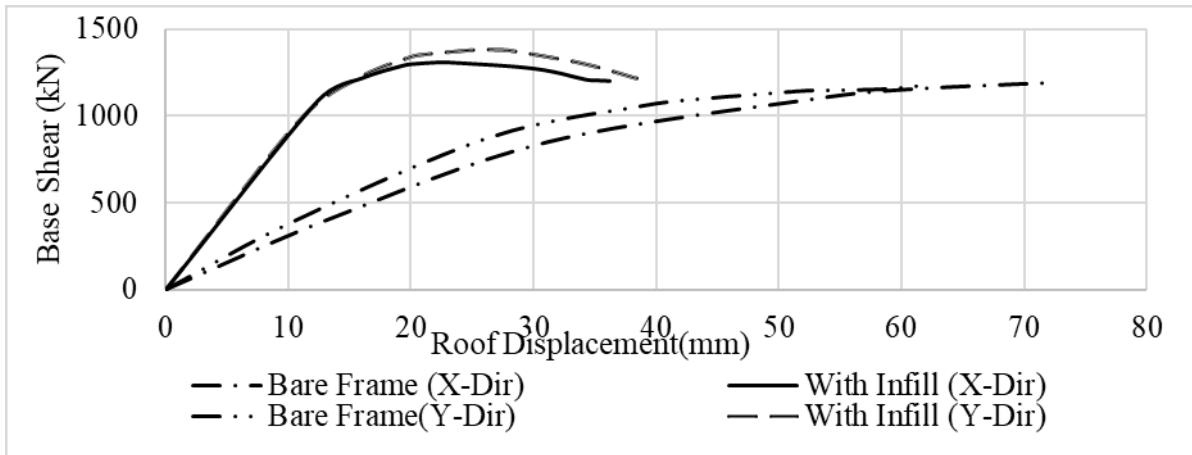

Figure 10 Pushover curve for Model 9

Figure 10 provides a pushover curve for model 9. Outside walls are of 230 mm size and inside of 115 mm with openings. Columns are not in a grid along both directions.

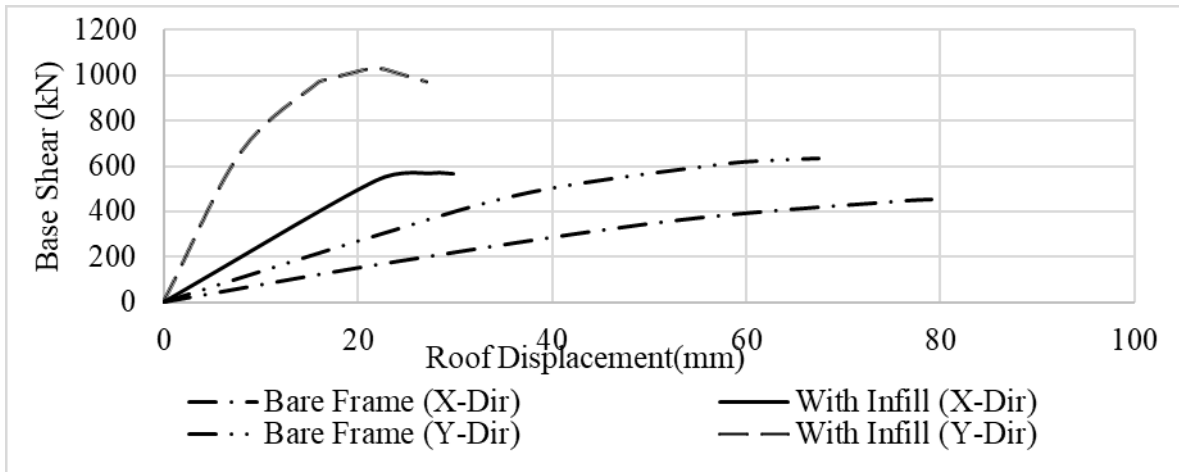

Figure 11 Pushover curve for Model 10

Figure 11 states a pushover curve for model 10. Higher rise in Y direction is observed due to presence of 230 mm wall and lower in Y due to 115 wall. Pushover curves for bare frames are at different positions due to irregular size columns in two directions. Similarly, Over-strength and Ductility factors for bare frame and infill models were calculated and results are presented in table 4.

Table 4 Over-strength and Ductility factors for bare frame and infill models

Model		Over strength Factor		Ductility factor	
		X-Dir	Y-Dir	X-Dir	Y-Dir
Model 1	Bare frame	3.223	2.911	2.246	2.745
	With infill	4.874	4.123	2.021	2.280
Model 2	Bare frame	1.756	1.609	3.238	3.277
	With infill	2.453	3.274	2.471	2.315
Model 3	Bare frame	1.528	1.512	3.459	3.697
	With infill	4.641	4.661	1.969	1.959
Model 4	Bare frame	1.772	1.923	2.737	2.921
	With infill	2.637	2.366	1.898	2.590
Model 5	Bare frame	0.897	0.914	2.423	2.689
	With infill	1.302	2.140	1.799	1.513
Model 6	Bare frame	1.174	1.190	2.737	2.993
	With infill	1.438	2.665	1.711	1.460
Model 7	Bare frame	0.798	0.845	2.989	2.398
	With infill	1.598	2.169	2.070	1.587
Model 8	Bare frame	0.820	0.945	2.318	2.601
	With infill	1.608	2.522	1.654	1.523
Model 9	Bare frame	2.582	2.719	2.703	2.621
	With infill	3.510	3.731	1.664	1.867
Model 10	Bare frame	0.487	0.769	2.118	2.367
	With infill	0.882	1.600	1.576	1.530

NBC provides Over-strength factor for seismic load calculation as 1.5 and ductility factor as 4. In consideration of bare frame models only buildings constructed with column sizes 300 mm x 300 mm up to 3 storey and staircase opening were found to comply within the requirements as suggested by the code. This is demonstrated from results in model 1, 2, 4 and 9. Similarly, a two storey 230 mm x 230 mm column building was found to be within this restriction. There has been an increase in the Over-strength factor of the building with consideration of masonry infill. This increase is dependent on the size of the wall along a direction. Moreover, the increase in Over-strength factor is found to increase in buildings with smaller column sizes since the contribution provided by infill walls is higher. Ductility factor has reduced in all the buildings. Moreover, ductility factors for none of the buildings with column sizes were found to comply with the value suggested to NBC 105:2020. So, the sizes of the building elements are found to be insufficient as per NBC 105:2020.

Regression analysis was done to observe changes observed in the Over strength and ductility factor in the above building. Change in Over-strength and ductility are defined in terms of two factors:

1. Over-strength increment factor: It is the ratio of Over-strength factor in the building with consideration of masonry infill to Over-strength factor without consideration of masonry infill or as a bare frame.
2. Ductility decrement factor: It is the ratio of Over-strength factor in the building with consideration of masonry infill to Over-strength factor without consideration of masonry infill or as a bare frame.

Wall sizes of 230 mm and 115 mm with reduction for opening in plan. The equations for Over-strength increment factor and Ductility decrement factor were devised.

Over-strength increment factor:

$$\text{Over-strength increment factor} = 1 + 6.25A^{3.027} + 0.893B^{1.097}$$

Ductility decrement factor:

$$\text{Ductility decrement factor} = 1 - 1.104A^{2.306} - 0.372B^{0.667}$$

Where, A- Ratio of 230 mm wall along a direction reduced by opening with respect to total length of bays in that direction

B- Ratio of 115 mm wall along a direction reduced by opening with respect to total length of bays in that direction.

## Conclusions

There was an expected rise in the ultimate strength of buildings with consideration of masonry infill in pushover analysis of the building. It is quantified with calculation of Over-strength and Ductility factor of the building. There was an increase in Over-strength factor due to presence of masonry infill, but the buildings were found to have inadequate ductility factor as per NBC 105:2020. Over-strength factor for 300x300 column complied with NBC provisions for up to 4 storey.

With the changes observed in the Over-strength and ductility factor of the models, nonlinear regression analysis was conducted and an equation was devised. From the analysis two different equations were coined and called over-strength increment factor and ductility reduction factor. These equations incorporates length of masonry wall in buildings with reduction in openings at masonry wall in plan to the total length of bays along the direction. Since most of the low storey buildings are constructed with masonry walls of size 230 mm and 115 mm, only these values are considered in the equation. For consideration of buildings without masonry walls, the value of length of walls will be zero and thus the value will equal to one. So, the equations devised will provide a factor for conversion of over-strength factor and ductility factor from a bare frame model consideration to infill wall consideration with the percentage of walls along a direction. This will also indicate the change in strength and ductility of the building due to the presence of infill walls in the building

## Conflict of interest

No conflict of interest.

## Acknowledgements

We would like acknowledge all the municipal engineers who have assisted in our research by providing municipal drawings submitted to the municipality

## References

- [1] B. of Physical Planning and Works, "Nepal National Building Code NBC:000," p. 16.
- [2] B. Sun and P. Yan, "Damage characteristics and seismic capacity of buildings during Nepal M s 8.1 earthquake," *Earthq. Eng. Eng. Vib.*, vol. 14, no. 3, pp. 571–578, Sep. 2015, doi: 10.1007/s11803-015-0046-x.

- [3] H. Chaulagain, H. Rodrigues, J. Jara, E. Spacone, and H. Varum, "Seismic response of current RC buildings in Nepal: A comparative analysis of different design/construction," *Eng Struct*, vol. 49, pp. 284–294, Apr. 2013, doi: 10.1016/j.engstruct.2012.10.036.
- [4] J. M. Humar, D. Lau, and J.-R. Pierre, "Performance of buildings during the 2001 Bhuj earthquake," *Can. J. Civ. Eng.*, vol. 28, no. 6, pp. 979–991, Dec. 2001, doi: 10.1139/101-070.
- [5] R. Dumar, H. Rodrigues, A. Furtado, and H. Varum, "Seismic Vulnerability and Parametric Study on a Bare Frame Building in Nepal," *Front. Built Environ.*, vol. 2, Dec. 2016, doi: 10.3389/fbuil.2016.00031.
- [6] I. S. 1893:2016 P. 1, "IS 1893:2016 Part 1," p. 44, 2016.
- [7] S. Phaiju and P. M. Pradhan, "Experimental work for mechanical properties of brick and masonry panel," *Jnl Sci. Engg.*, vol. 5, pp. 51–57, Aug. 2018, doi: 10.3126/jsce.v5i0.22372.
- [8] P. Rajbhandari, "Response Reduction Factor for Seismic Design of Buildings in Nepal," Department of Civil Engineering, Tribhuvan University, Nepal., 2019.
- [9] G. Al-Chaar, "Evaluating Strength and Stiffness of Unreinforced Masonry Infill Structures Some of the authors of this publication are also working on these related projects: 3D Printing, Method of construction for Geopolymer soil stablization View project Emerging materials for lightweight ferro-cement structural systems View project," 2014.
- [10] M. Dolšek and P. Fajfar, "The effect of masonry infills on the seismic response of a four-storey reinforced concrete frame – a deterministic assessment," *Eng Struct*, vol. 30, no. 7, pp. 1991–2001, 2008, doi: <https://doi.org/10.1016/j.engstruct.2008.01.001>.
- [11] E. Miranda, "Site Dependent Strength Reduction Factors," *Journal of Structural Engineering*, vol. 119(12), pp. 3503–3519., 1993.[6] A. Rangone, "Innovation and Technology: The Age of the Digital Enterprise," in *Managing Corporate Innovation: Determinants, Critical Issues and Success Factors*, ed Cham: Springer International Publishing, 2020, pp. 49-68.